

DMI TABLE HOCKEY MODEL: HTSIMP1 PARTS IDENTIFIER













<p>①</p>  <p>(1EA)</p>	<p>②</p>  <p>RIGHT LEG (2EA)</p>	<p>③</p>  <p>LEFT LEG (2EA)</p>	<p>④</p>  <p>3.5X14MM FLAT HEAD SCREW (4EA)</p>	<p>⑤</p>  <p>22MM FLAT WASHER (12EA)</p>
<p>⑥</p>  <p>8X30MM ALLEN KEY LEG BOLT (12EA)</p>	<p>⑦</p>  <p>HINGED GOAL (2EA)</p>	<p>⑧</p>  <p>LEG LEVELER (4 EA)</p>	<p>⑨ (PRE-INSTALLED)</p>  <p>HOCKEY MOTOR (1EA)</p>	<p>⑩</p>  <p>PUCK (2EA)</p>
<p>⑪</p>  <p>PUSHER (2EA)</p>	<p>⑫</p>  <p>3.5X10.5MM WASHER HEADSCREW (4EA)</p>	<p>⑬</p>  <p>ALLEN KEY (1EA)</p>		

FIG:1

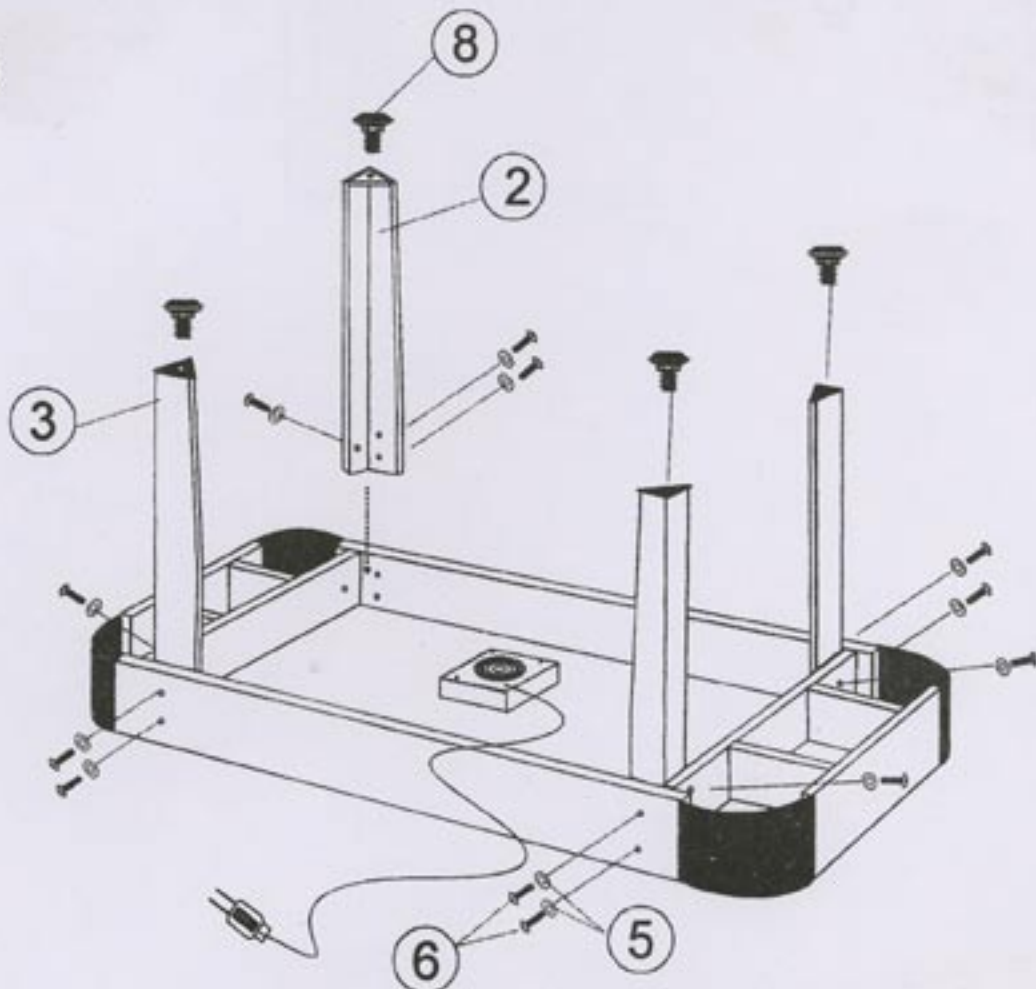

FIG:2

